

TRIBOLOGY CONVENTION 1970

Tilting pad thrust bearings: factors affecting performance and improvements with directed lubrication

M. K. BIELEC and A. J. LEOPARD

Research and Development Organization, The Glacier Metal Co., Ltd,
Wembley, Middlesex, England

REPRINTED BY PERMISSION OF THE INSTITUTION OF MECHANICAL ENGINEERS

1 BIRDCAGE WALK · WESTMINSTER · LONDON · S.W.1.

© The Institution of Mechanical Engineers 1970
Reprinted from Vol. 184, Pt 3L of the Institution's Proceedings
by permission of the Council

TILTING PAD THRUST BEARINGS: FACTORS AFFECTING PERFORMANCE AND IMPROVEMENTS WITH DIRECTED LUBRICATION

M. K. Bielec* A. J. Leopard†

The effect on flooded tilting pad thrust bearing performance of a number of external variables is examined. At sliding speeds between 10 and 100 m/s, and for specific pressure between 15 bar and 55 bar, measurements were made of oil film thickness, bearing temperature, and power loss for various oil inlet systems, oil quantities, housing pressures, and degrees of misalignment. Power consumption in high-speed thrust bearings can be safely reduced by the use of directed lubrication with a drained casing, bearing temperature being reduced and oil film thickness increased.

INTRODUCTION

TILTING PAD THRUST BEARINGS operating at high sliding speeds (in excess of 60 m/s) may fail owing to high pad surface temperatures. The object of the work described in this paper was primarily to investigate the effectiveness of current methods used for the design of high-speed assemblies, and to evaluate improvements. The paper also studies the effects of speed, load, oil quantity, oil pressure, misalignment, and oil flow arrangement on a flood lubricated double thrust bearing. The final section considers the problem of power loss in high-speed tilting pad thrust assemblies and shows how significant savings can be made by using a different system of lubrication (directed lubrication).

EXPERIMENTAL EQUIPMENT

The Orion test rig shown in Fig. 13.1 was used for the majority of the work described. A 124-mm o.d. double tilting pad thrust bearing assembly was used, in which each thrust ring incorporated eight white-metal faced, steel backed, centre pivoted thrust pads, 28 mm wide. To enable accurate friction torque measurements to be made, the double thrust bearing was supported in a test head mounted on hydrostatic journal bearings with the thrust load applied by means of hydrostatic pistons. The 55-mm

test shaft was driven at speeds up to 15 000 rev/min by a 56-kW variable-speed d.c. motor. Lubricating oil was supplied to the test head from an external circuit which incorporated heaters, coolers, pressure and temperature controls, etc., to maintain the lubricant within the required parameters for each test. Shaft speed was measured with an electronic counter, and friction torque by means of a spring balance.

For the early tests the bearing performance was estimated mainly by means of copper-constantan thermocouples embedded within about 0.05 mm of the bearing surface. Later tests used film thickness probes embedded in selected thrust pads. These probes were of the capacitance type with the signal being read on an inductive ratioing instrument (1)‡. Up to eight thermocouples were used in some pads, and a typical set of instrumented pads is shown in Fig. 13.2.

For many of the initial tests on the directed lubrication system of oil supply described later in this paper, a relatively simple test rig (Scylla) was used. This rig permitted larger thrust pads (68 mm) to be tested on a 750-mm o.d. thrust collar at speeds up to 3000 rev/min, which enabled a mean sliding speed of 100 m/s to be achieved compared with the maximum of 76 m/s that was possible on the Orion rig. To minimize power requirements and to simplify loading arrangements the Scylla rig incorporated two pairs of thrust pads, each pair being hydraulically loaded against opposite sides of the thrust collar so that

The MS. of this paper was received at the Institution on 30th November 1969 and accepted for publication on 23rd January 1970. 33

* Research Engineer, R. and D. Dept, The Glacier Metal Co. Ltd, Alperton, Wembley, Middlesex.

† Manager, Tilting Pad Bearing Section, The Glacier Metal Co. Ltd, Alperton, Wembley, Middlesex.

‡ References are given in Appendix 13.1.

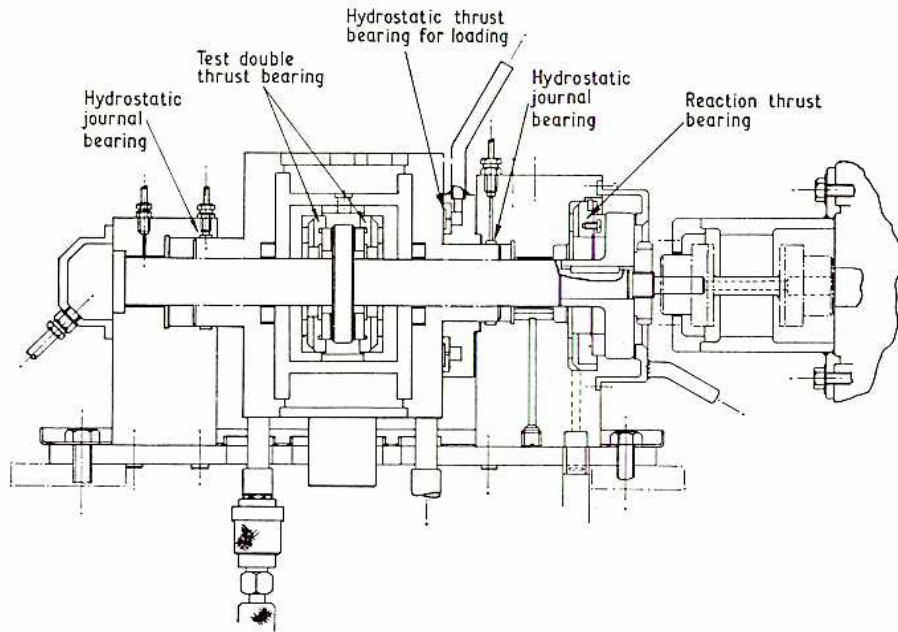

Fig. 13.1. Orion test rig

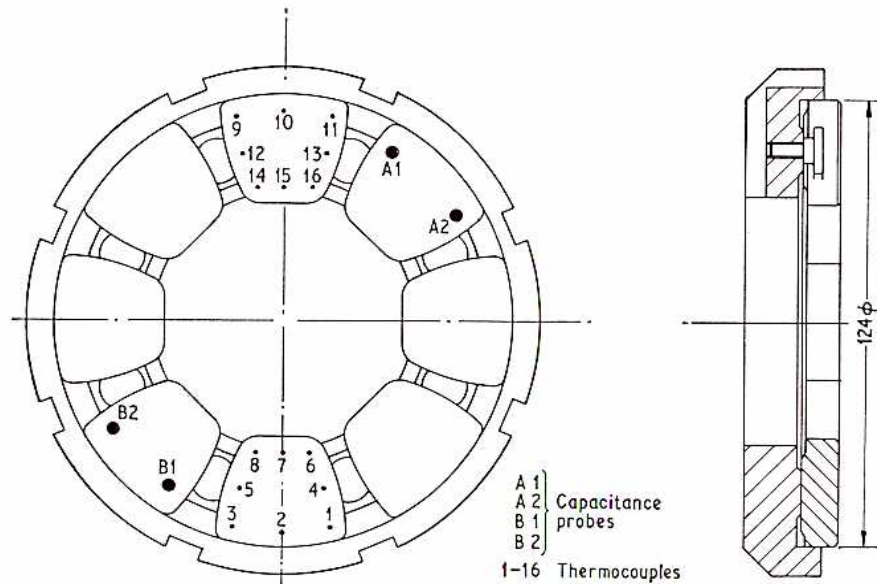

Fig. 13.2. Test thrust bearing with instrumentation positions

there was no resultant axial thrust. Instrumentation consisted of thrust pad temperature thermocouples, oil flow quantity, pressure, temperature, shaft speed, and applied thrust. It was found that results obtained on this simple rig could be subsequently confirmed on the Orion rig.

All the work described in this paper used a mineral oil with a viscosity of 41 cS at 50°C, 8.4 cS at 100°C. The majority of the tests were carried out with an oil inlet temperature of 50°C.

GENERAL CHARACTERISTICS OF TILTING PAD THRUST BEARINGS

The work described in this section was aimed at confirming, under controlled test conditions, the effects of different operating parameters on the performance of the bearing.

Effect of speed and load

Fig. 13.3a shows the effect of speed on the bearing

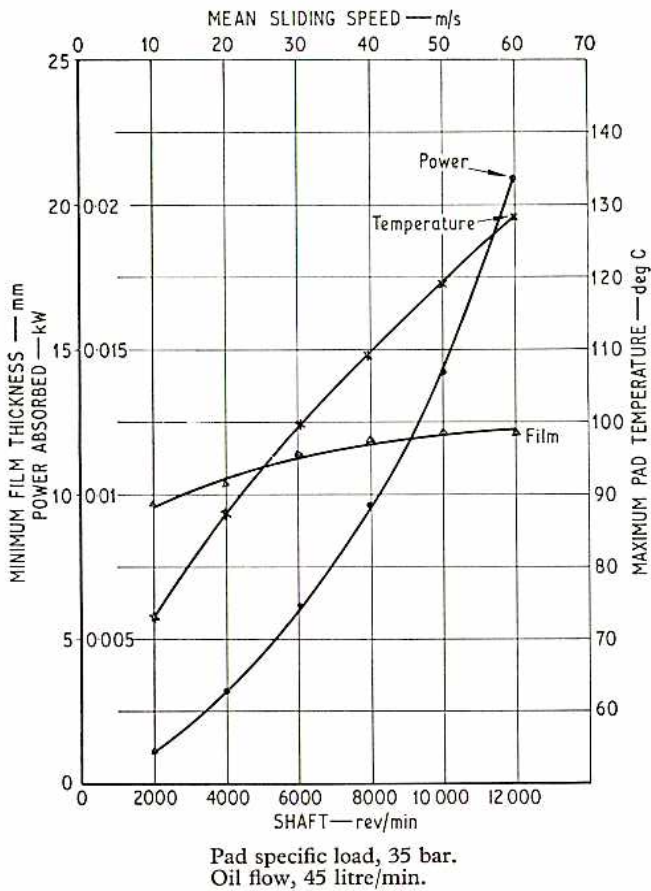

Fig. 13.3a. Effect of speed on bearing operating parameters with constant pad specific loading

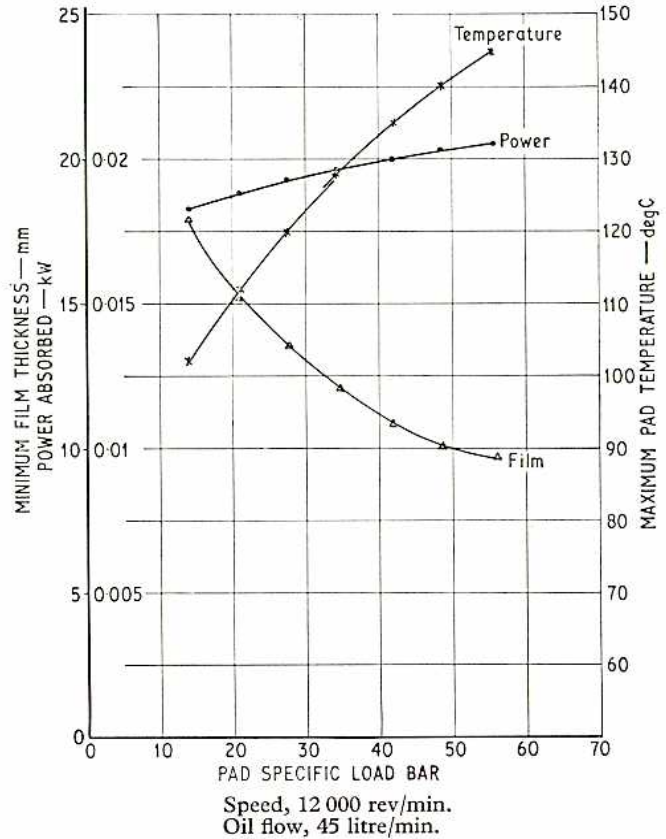

Fig. 13.3b. Effect of pad specific loading on bearing operating parameters at constant speed

performance with a typical specific load of 35 bar*. At high sliding speeds the power absorbed increases nearly as the square of the speed. In addition to shearing losses beneath the pads, the power absorbed also includes drag losses on the exposed parts of the thrust collar and shaft. The drag losses (or churning losses) can amount to 50 per cent or more of the total losses at high sliding speeds. There is also a rapid increase with speed in maximum pad temperature, which arises partly from the higher shearing rate and partly from the increased hot oil carry-over from one pad to the next. The high pad temperature represents a real limit to bearing loading (2), not only because the white-metal may lose its strength and begin to flow plastically but also for reasons concerned with thermal fatigue, sometimes known as thermal ratcheting (3).

The effect of pad specific loading at a constant high speed (12 000 rev/min) is shown in Fig. 13.3b. The relatively slow increase in power absorbed with increasing load will be noted, showing that a considerable proportion of the power reduction is attributable to churning losses. It follows from Figs 13.3a and b that the rate of increase of pad temperature due to speed is of the same order as that due to load. This has the practical effect of making it

* 1 bar = 14.50 lbf/in² = 10⁵ N/m².

difficult to reduce maximum pad temperatures by using a larger bearing as any decrease in temperature due to lower loading can be largely offset by the increase in mean sliding speed at the thrust pad.

Effect of oil supply arrangement

Different arrangements of oil inlet and outlet positions in conjunction with different oil flow patterns inside the bearing were studied to see how they affect the supply of fresh cool oil to the pads. The merits of each arrangement were judged by the measured pad temperatures. The principal arrangements tested are shown in Fig. 13.4. The main oil flow path through the bearing was varied by using a combination of different oil inlet and outlet positions in conjunction with full or partial recirculation slots in the carrier rings. From simple considerations of oil flow it could be thought that the best arrangement is given by (V) where the total flow is supplied at the inner periphery of the loaded face and discharged at the surge face. On the other hand, the worst arrangement would seem to be (III), in which the oil enters opposite the collar and has to flow against the collar's centrifugal gradient to lubricate the pads; furthermore, most of the oil could pass around the collar and be discharged at the top without ever reaching the pad inlet edge.

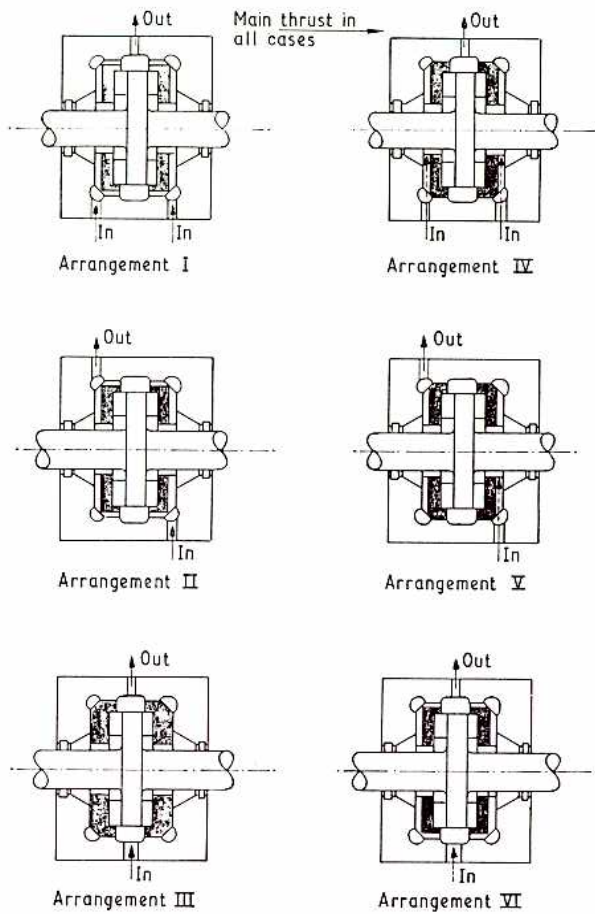

Fig. 13.4. Oil supply arrangements

The change in maximum pad temperature versus speed is shown in Fig. 13.5 for each of the six arrangements in Fig. 13.4, and it will be seen that the different oil flow arrangements have only a marginal influence on maximum pad temperatures. This was attributed to the extensive churning and mixing of the oil within the casing which was induced by the rotating thrust collar, and by this method a fairly uniform oil bath temperature is maintained irrespective of oil entry arrangements or oil flow inside the bearing.

Effect of oil quantity

The oil temperature rise through a tilting pad bearing assembly (i.e. the difference in housing oil inlet and outlet temperatures) is a parameter used extensively in design and operation.

Fig. 13.6 shows the effect of oil quantity on the maximum pad temperature of a bearing operating at 6000 and 8000 rev/min with the corresponding temperature rise marked against each test point. It will be seen that increasing the oil flow to give temperature rises of less than 15–20 degC has little beneficial effect on bearing performance as measured by pad surface temperature. Conversely, however, relatively large changes in pad

surface temperature can occur with small oil flows, i.e. at high temperature rises.

Effect of oil pressure

At low sliding speeds a bearing performs satisfactorily when immersed in an unpressurized oil bath, but at higher speeds the centrifugal effects of the collar on the surrounding oil become substantial. Recirculation slots are provided at the back of the carrier ring to equalize the pressure gradients created by the collar, but their success is only partial.

Tests were carried out at constant speeds to measure the static pressures at the outer and inner peripheries of the pads for given oil supply pressures. Fig. 13.7 shows the results for 9000 rev/min, which was the maximum possible test rig speed when the tests were performed. It will be seen that pressures at the outer periphery of the pads were substantially less than the supply pressure, and pressures below atmospheric were measured at the inner periphery of the pads with low oil supply pressures. This was particularly noticeable at high speeds where higher temperature readings indicated oil starvation at the pad inlet. These sub-atmospheric pressures can be avoided by increasing the supply pressure. Other workers (4) have shown that the safety factor of a tilting pad thrust bearing

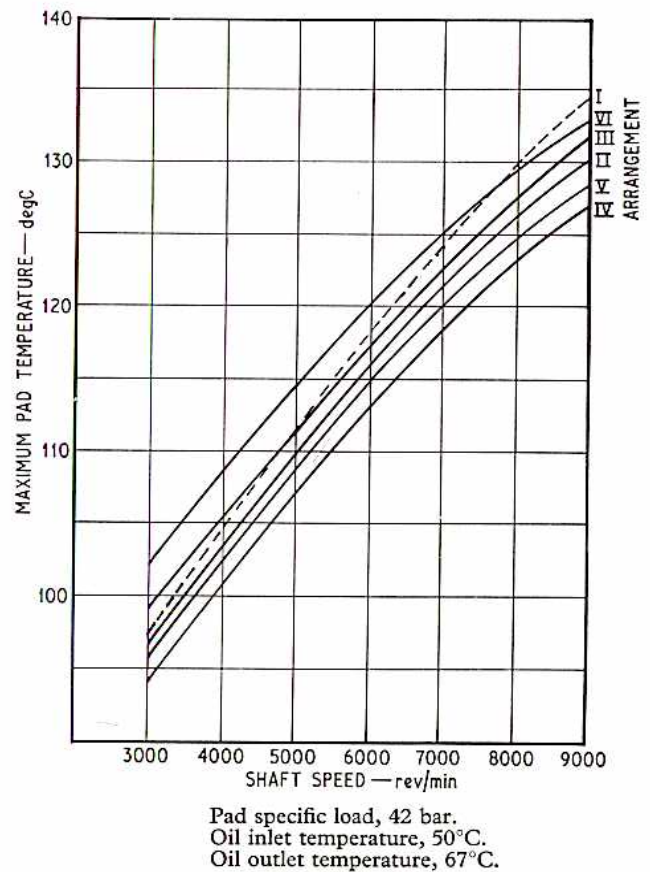
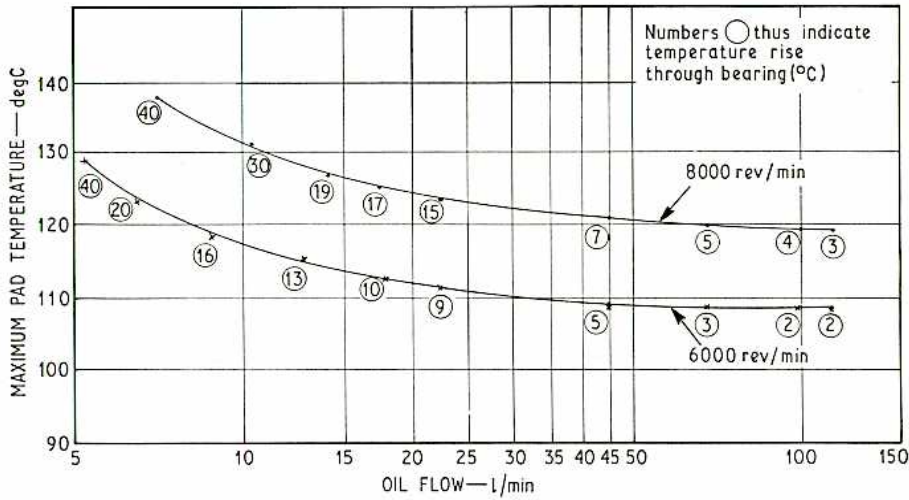

Fig. 13.5. Effect of oil flow arrangements shown in Fig. 13.4 on maximum pad temperature



Pad specific load, 42 bar. Oil inlet temperature, 50°C.
Fig. 13.6. Effect of oil flow on maximum pad temperature

is increased by raising the housing pressure to relatively high values (10 bar), but from tests performed it is concluded that supply pressures in the range of 1–1.5 bar are sufficient for the majority of modern applications.

Effect of misalignment

About 0.015 mm is a typical order of magnitude for the minimum film thickness separating the rotating collar from the pads. Thus, to ensure a reasonable load distribution a very high degree of alignment is required between the components concerned. Fundamentally there are three main types of misalignment:

- (1) differing pad heights;
- (2) misaligned thrust collar with respect to thrust face in moving plane ('swash plate action');
- (3) misaligned pad carrier ring with respect to the collar face in a static plane (a) when initially assembled and (b) when machine running.

The first two types can best be dealt with by proper machining and inspection. The third form, which in some cases can be quite large, is the most difficult to predict and control. Several methods are used to ensure an aligned support, e.g. lever type equalizing rings, hydraulic pistons, springs, and spherical seats. Tests (5) have indicated that the lever type equalizing ring does not deal very effectively with changes in alignment of the bearing support, probably due to the high friction at the transfer points between the levers. Hydraulic pistons give excellent performance but are expensive. With springs, the amount of compensation is limited by the permissible axial movement. The action of a spherical seat, whilst suitable for adjustment of alignment at assembly, has poor self-aligning properties under load owing to friction effects.

An ideal support should have high axial stiffness combined with freedom to tilt diametrically. Supporting the bearing on a fluid-filled flexible ring meets these requirements, and such a device is shown in Fig. 13.8.

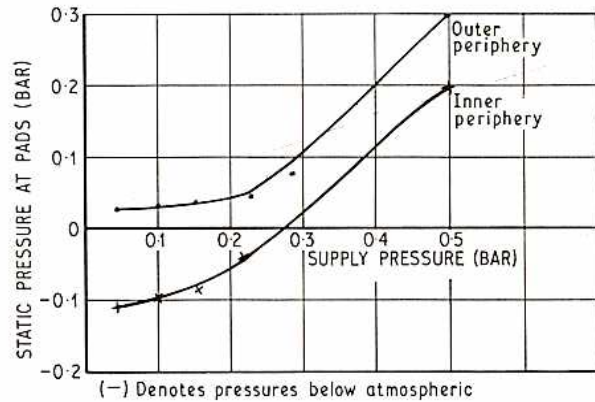

Fig. 13.7. Effect of oil supply pressure on static pressures at inner and outer peripheries of thrust pad at 9000 rev/min

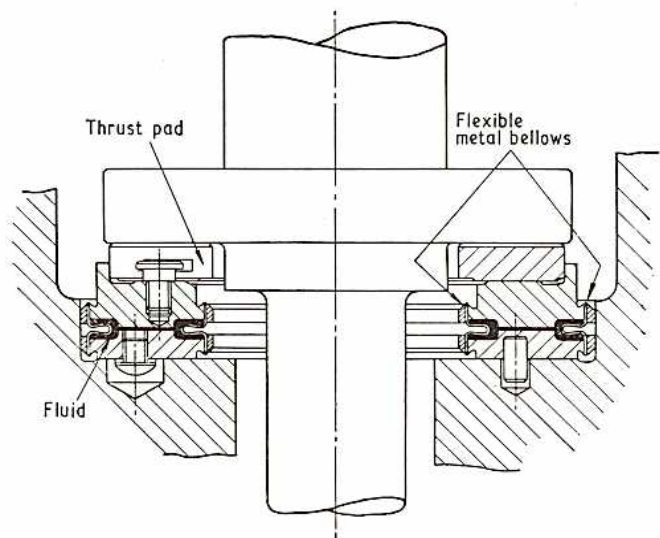
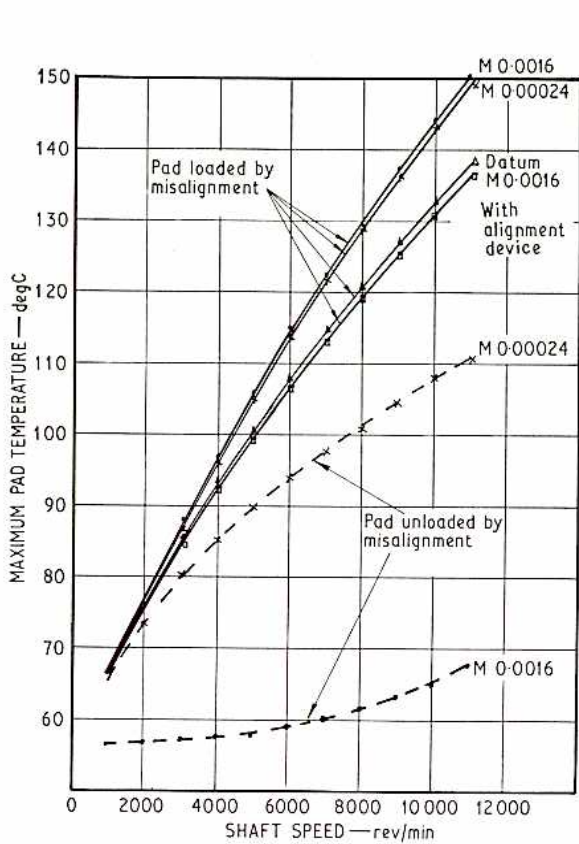
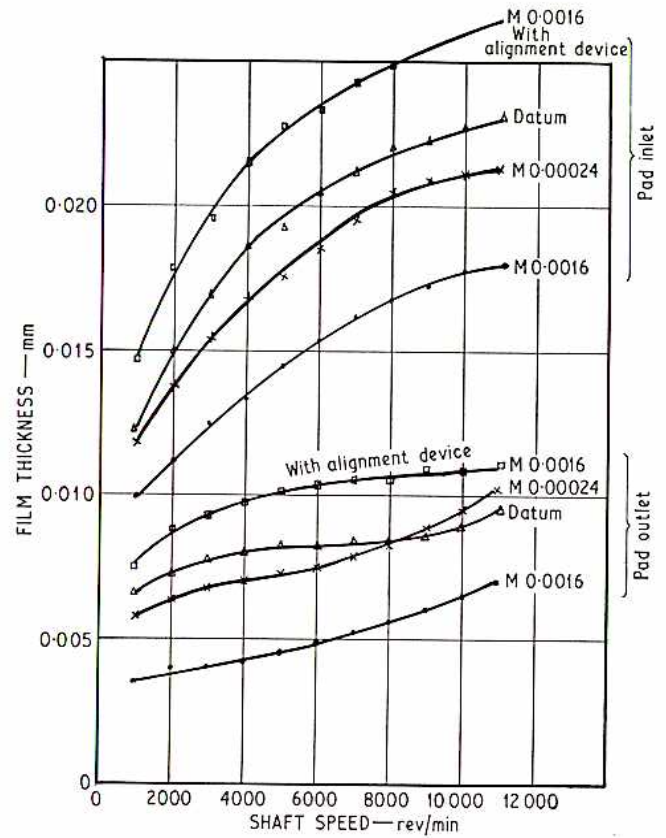

Fig. 13.8. Fluid filled alignment device



Pad specific load, 35 bar.
Oil flow, 23 litre/min.
M denotes alignment in m/m.

Fig. 13.9a. Effect of support misalignment at various speeds on maximum pad temperature



Pad specific load, 35 bar.
Oil flow, 23 litre/min.
M denotes alignment in m/m.

Fig. 13.9c. Effect of support misalignment on film thickness

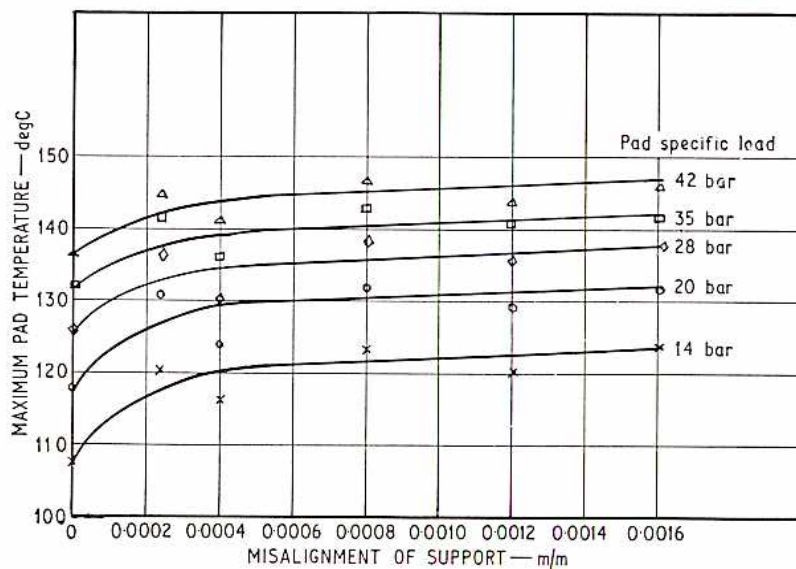

Speed, 10 000 rev/min. Oil flow, 23 litre/min.

Fig. 13.9b. Effect of support misalignment on maximum pad temperature

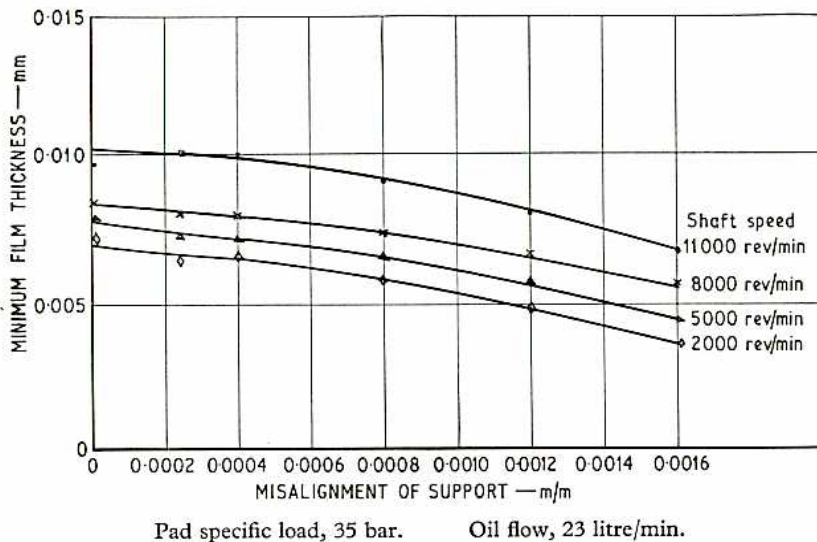

Fig. 13.9d. Effect of support misalignment on minimum film thickness

A series of tests were carried out in which a thrust ring was supported on misaligned supports to determine the effect of misalignment of type (3). In these tests the maximum misalignment tested was 0.0016 m/m and, in addition to the normal Orion instrumentation, capacitance probes were fitted to the pad carrier ring to determine its true misalignment with respect to the thrust collar. It is of interest that at specific loads in excess of 15 bar, the amount of misalignment measured by these probes was only 30–50 per cent of that nominally imparted to the carrier ring by its tapered support.

Some of the results from these tests are shown in Fig. 13.9a–d. To simplify graphical presentation, only the results on the plane of misalignment of the support for a nominal bearing specific loading of 35 bar are shown.

From Figs 13.9a and b it can be seen that the pad surface temperature is scarcely affected by misalignment at low speed (1000 rev/min) but is considerably affected at high speed (11 000 rev/min). It is also noteworthy that the pad temperatures rise rapidly with initial small amounts of misalignment, after which further misalignment has a negligible effect.

Figs 13.9c and d show the effect of misalignment on the oil film thickness and it will be seen that both pad inlet and outlet film thicknesses were proportionately reduced as misalignment was increased. It was estimated that the heaviest loaded pad under maximum misalignment conditions had a specific pressure in excess of 150 bar. It is considered that the apparent discrepancy between temperature and film thickness trends with increasing misalignment is caused by pad distortion.

The range of misalignments tested was consistent with that which can occur in practice, and illustrates one of the principal reasons for bearings being underrated in current industrial practice. When the thrust rings were supported on the device shown in Fig. 13.8, the pad temperatures and film thicknesses of the pads in the ring were as uniform

under maximum misalignment conditions as those that were recorded with the standard thrust ring after most careful machining and assembly (shown as datum curve in Fig. 13.9a). A strong case can therefore be made for loading thrust bearings more heavily if they are fitted with an effective alignment device.

METHODS OF REDUCING POWER LOSS

It has been mentioned earlier that churning losses in high-speed tilting pad thrust assemblies can represent 50 per cent or more of the total losses. For this reason various attempts have previously been made to reduce these losses by fitting seals to various parts of the assembly, and more radical improvements have recently been made by changing from the conventional 'fully flooded' method of lubrication.

Collar seals and 'L' seals

The commonest arrangement designed to reduce power loss is the collar seal, whose object is to maintain an air pocket around the thrust collar periphery and thus eliminate collar periphery drag losses. As these losses can be as high as 12 per cent of the total for a double thrust bearing, the use of these seals is attractive. Tests on the Orion rig, however, showed that fitting collar seals only resulted in a saving of about 3 per cent for the bearing operating at 9000 rev/min with an oil supply pressure of 1 bar. The reasons for this discrepancy between theory and practice are principally (a) power loss on the seals and (b) difficulty in draining the annulus around the collar sufficiently well to ensure complete aeration, taking into account the appreciable quantity of oil leaking through both seals.

Face type seals on the inner periphery of the thrust ring (sometimes called 'L' seals) have also been used to eliminate the drag losses on the periphery of the shaft.

Tests in the Orion rig failed to detect a power loss saving with a bearing fitted with this device; however, the theoretical saving for the case tested was only about 3 per cent of the total, which was the same order as the overall rig accuracy at the time of testing.

With the collar seals and the 'L' seals it was noted that the pad surface temperature was slightly but consistently higher (2–5 degC) than when the bearing was not fitted with these devices. As the use of these seals can involve more complicated oil supply systems and certain other practical disadvantages, their use can generally only be justified in special designs which have unusual geometric proportions.

Directed lubrication

Following the relatively unpromising results reported above on power loss reduction by means of seals, a more fundamental approach was felt to be required if any significant improvement was to be made. If 50 per cent or more of the power absorbed is due to churning losses in high-speed bearings, it should be possible to eliminate these completely if bearings could operate in a fully drained housing with oil only present in the areas between the thrust pads and the collar, i.e. where the hydrodynamic oil films are formed. The lubricating oil has therefore to be directed to the leading edge of every pad and removed from the trailing edge. In addition to saving power loss, this method should also improve bearing performance as it would eliminate hot oil carry-over from pad to pad. Such a system of lubrication is referred to as 'directed' lubrication.

The principal approaches were tried to meet the above requirements:

- (1) Nozzles were placed at the inner periphery of the bearing directed radially outwards towards the leading and trailing edges of the pads.
- (2) Combined nozzle/scrapper blocks were placed between each pair of pads. The nozzles were arranged along the whole radial width of the pads and were directed towards leading and (in some cases) trailing edges of the pads.
- (3) Conical nozzle systems were incorporated in the stop pins situated between each thrust pad. These are referred to as umbrella sprayer nozzles.

It may be noted that the first and third approaches use jets of oil to scour the hot oil carry-over from the collar, while the second approach is designed to remove this oil by scraping.

Initial investigation and development of these systems was carried out on the Scylla rig. The principal criteria used to evaluate the systems were maximum pad surface temperature and oil flow for given operating conditions; measurements of motor current enabled a rough assessment of power absorbed to be made. It was found that the umbrella sprayer nozzles showed a marked superiority over the other systems, especially at the highest speeds and loads tested (3000 rev/min = 100 m/s at 57 bar).

Following these initial results further tests were carried out to optimize the design of the umbrella sprayer nozzle in terms of jet size, jet angle, number of jets per nozzle, jet velocity, and oil quantity. These tests emphasized the importance of jet momentum in the removal of hot oil carry-over. A typical thrust bearing fitted with umbrella sprayer nozzles is shown in Fig. 13.10.

A final series of tests were carried out on the Orion rig which enabled a direct comparison to be made between flooded and directed lubrication bearings with accurate measurements being made of power absorbed, pad temperature, film thickness, etc. The power available limited the maximum speed of these tests to 60 m/s (12 000 rev/min) for flooded lubrication and 76 m/s (15 000 rev/min) for directed lubrication.

Fig. 13.11a shows typical test results in which it will be seen that even at the relatively low speed of 60 m/s the directed lubrication bearing achieved a reduction in power loss of 45 per cent. A very practical demonstration of this was that the Orion rig was limited to 9000 rev/min when all its thrust bearings were flood lubricated; after conversion of the test double thrust bearing and the reaction thrust bearing to directed lubrication it was possible to run at 15 000 rev/min. The curves in Fig. 13.11b for maximum pad temperature show that the bearing runs cooler with directed lubrication at all speeds, and this difference increases with speed and becomes substantial (10–20 degC) at high sliding speeds. It is interesting to note that the bearing with directed lubrication can support 14 bar greater pad specific loading for the same maximum pad

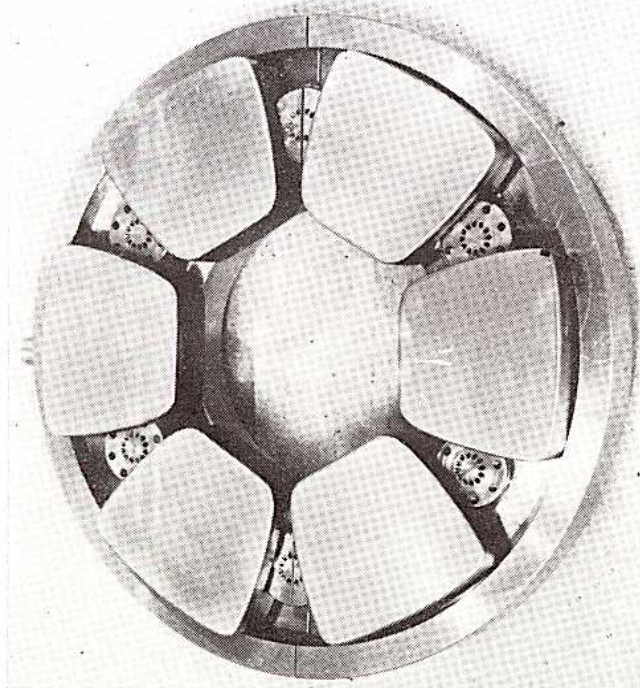

Fig. 13.10. 240 mm o.d. tilting pad thrust bearing fitted for directed lubrication

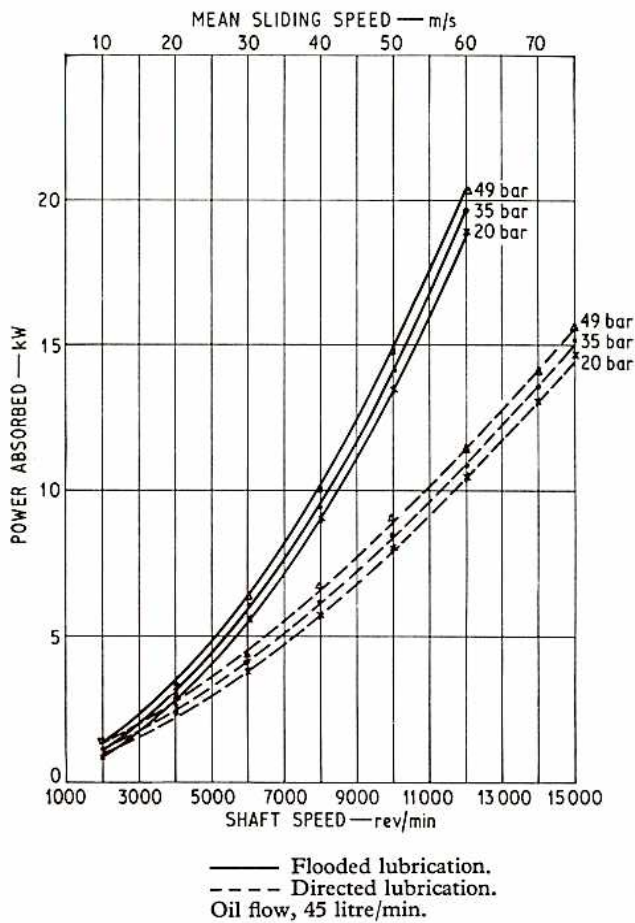

Fig. 13.11a. Comparison of power absorbed by flooded and directed lubrication

temperature at a sliding speed of 60 m/s. This is an important finding, since in high-speed applications the pad specific load is frequently reduced to keep the pad temperature low. Therefore, the use of directed lubrication permits higher specific loading, thus requiring a smaller bearing to support a given load; this in turn leads to further saving in power due to a reduced bearing diameter. Elimination of the parasitic churning losses in combination with a smaller bearing selection can lead to 70 per cent or more reduction in the power absorbed by a double thrust bearing required to support a given load at high (100 m/s) sliding speeds.

Although the minimum film thickness is not a limiting criterion in high-speed tilting pad thrust bearings, the curves for the two systems of lubrication (Fig. 13.11c) show that the bearing with directed lubrication operates with a substantially thicker oil film, because cooler oil is supplied direct to the pad inlet.

In the event of the loss of oil supply pressure, a flood lubricated tilting pad thrust bearing would at first sight appear to have an inbuilt advantage over a directed lubrication bearing as it has an oil reservoir in the casing. However, it should be noted that in high-speed bearings

a depressurized casing will result in a fairly rapid centrifuging of the oil away from the pads.

Fig. 13.12 shows some results from a series of tests designed to assess the sensitivity of directed lubrication to a reduction in oil supply pressure. Tests were also carried out on the effect of a complete failure of the oil supply. These showed that with a specific load of 35 bar at 3000 rev/min no damage to the pads had occurred 30 s after oil was cut off; at 9000 rev/min, however, wiping of the bearing surface commenced 13 s after oil was cut off. It is felt that these results are comparable with the effect of oil supply failure in high-speed journal bearings.

CONCLUSIONS

The following main conclusions may be drawn from the work described above:

- (1) The use of directed lubrication in high-speed thrust assemblies achieves substantial reductions in power absorbed, at the same time reducing the pad surface temperature and increasing the film thickness.
- (2) The use of seals in high-speed thrust assemblies to reduce power absorbed is of only small value.
- (3) The importance of accurate alignment has been demonstrated, and if considerable overloading of some

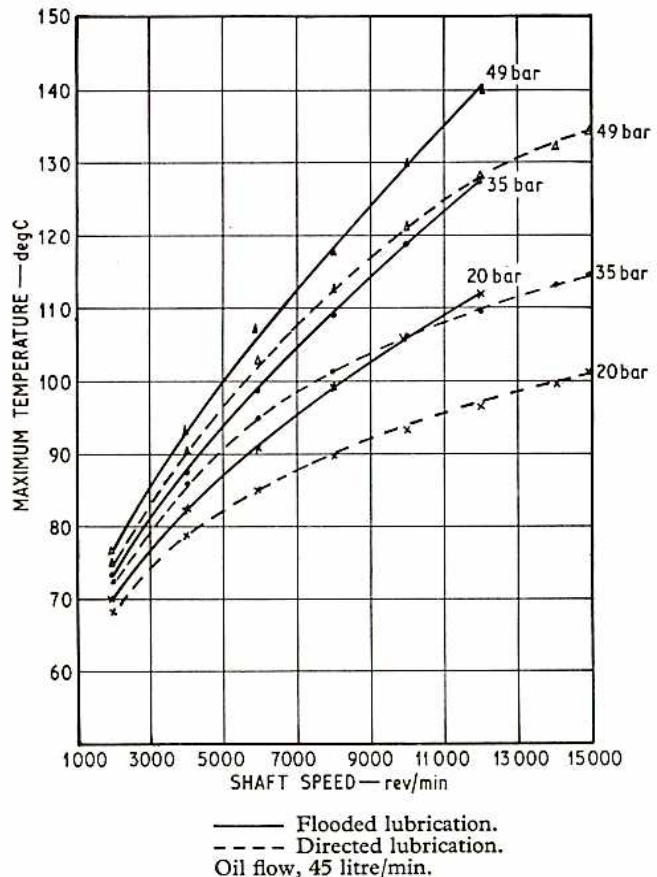

Fig. 13.11b. Comparison of maximum pad temperature with flooded and directed lubrication

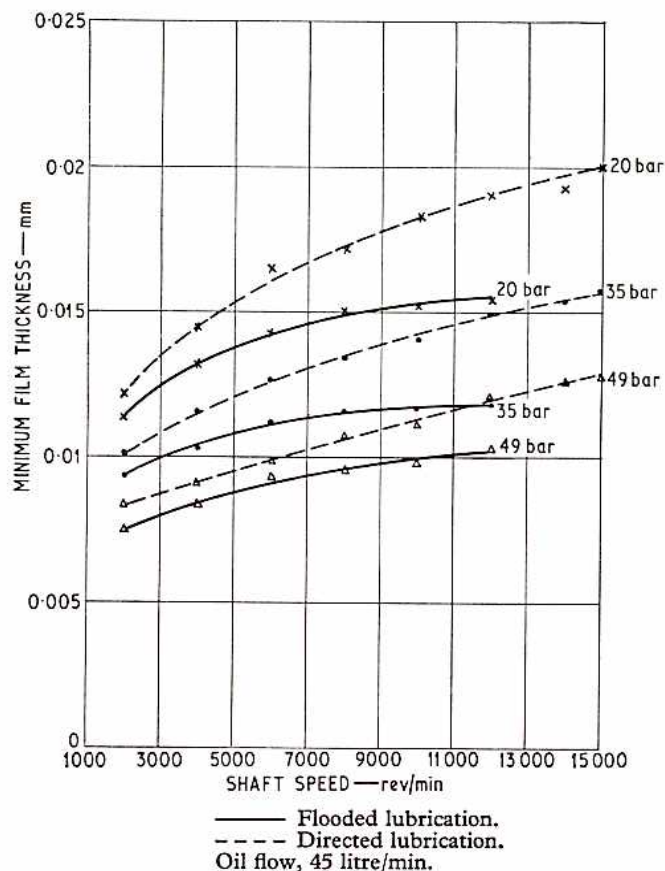

Fig. 13.11c. Comparison of minimum film thickness with flooded and directed lubrication

pads is not to result, with consequent reduction in bearing safety factor, it is necessary to achieve extremely high standards. It is possible to reduce the size of a bearing for a given load if an efficient alignment device is used.

(4) The use of relatively complicated internal and external oil flow arrangements for flood lubricated bearings can only achieve a limited improvement in pad surface temperature; at best, about 7 degC.

(5) Increasing the oil flow through the assembly is only of value if temperature rises in excess of about 20 degC are present.

(6) Sufficient oil pressure above ambient should be present in the housing of a flood lubricated bearing to avoid starvation of the oil supply to the pads due to centrifugal effects. For most applications, 1-1.5 bar is sufficient.

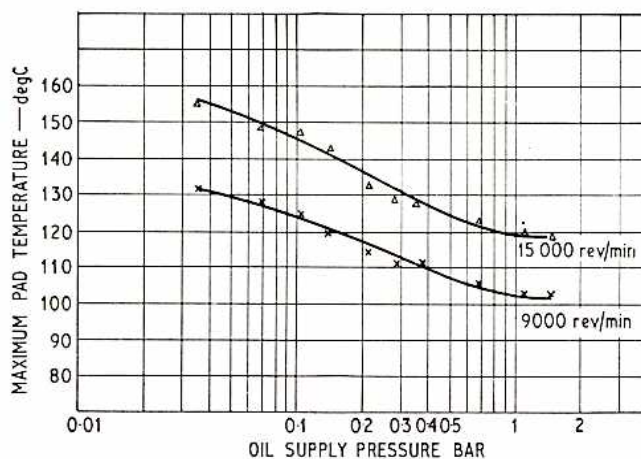

Pad specific load, 35 bar.

Fig. 13.12. Effect of reduced oil supply pressure with directed lubrication on maximum pad temperature

ACKNOWLEDGEMENTS

The authors would like to thank the Glacier Metal Co. Ltd for permission to publish this paper, and express their gratitude to all who assisted in its preparation. Acknowledgement is also made to the Ministry of Defence (D.G. Ships) for sponsoring part of the work on the Orion rig. Some features of directed lubrication described in this paper are covered by Glacier Metal Co. Ltd G.B. Patent No. 1 120 624, G.B. Patent Application No. 42 951/66 and corresponding foreign patents and applications.

APPENDIX 13.1

REFERENCES

- (1) BUTCHER, A. E. 'Developments in the measurement of oil-film thickness in dynamically loaded bearings', *Symp. Experimental Methods in Tribology, Proc. Instn mech. Engrs* 1967-68 182 (Pt 3G), 105.
- (2) MARTIN, F. A. 'Tilting pad thrust bearings: rapid design aids', Paper 16 at this Convention.
- (3) BOAS, W. and HONEYCOMBE, R. W. K. 'The deformation of tin base bearing alloys by heating and cooling', *J. Inst. Metals* 1947, 433.
- (4) TRIFONOV, E. V. and YAMPOLSKII, S. L. 'Effects of oil pressure on the load-carrying capacity of steam turbine thrust bearings', *Énergomashinostroenie* 1957 1, 8.
- (5) GUSTAFSON, R. E. 'Behaviour of a pivoted-pad thrust bearing during start-up', A.S.M.E. Paper 65-Lub-S-13, 1965 (June).